

MV1218-6 Plastic filling instruments

6

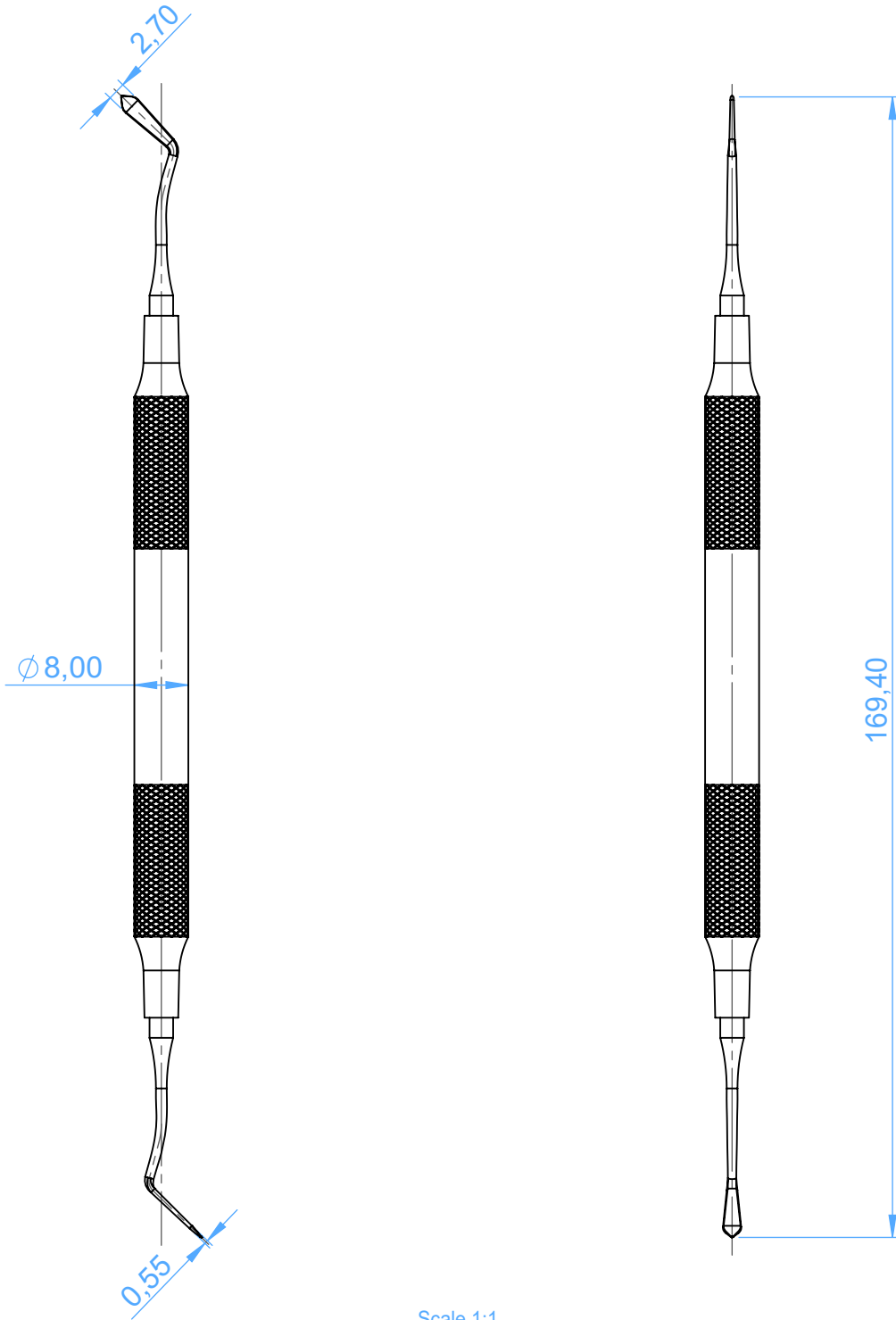

Scale 1:1