

1210-3 Plastic filling instruments

3

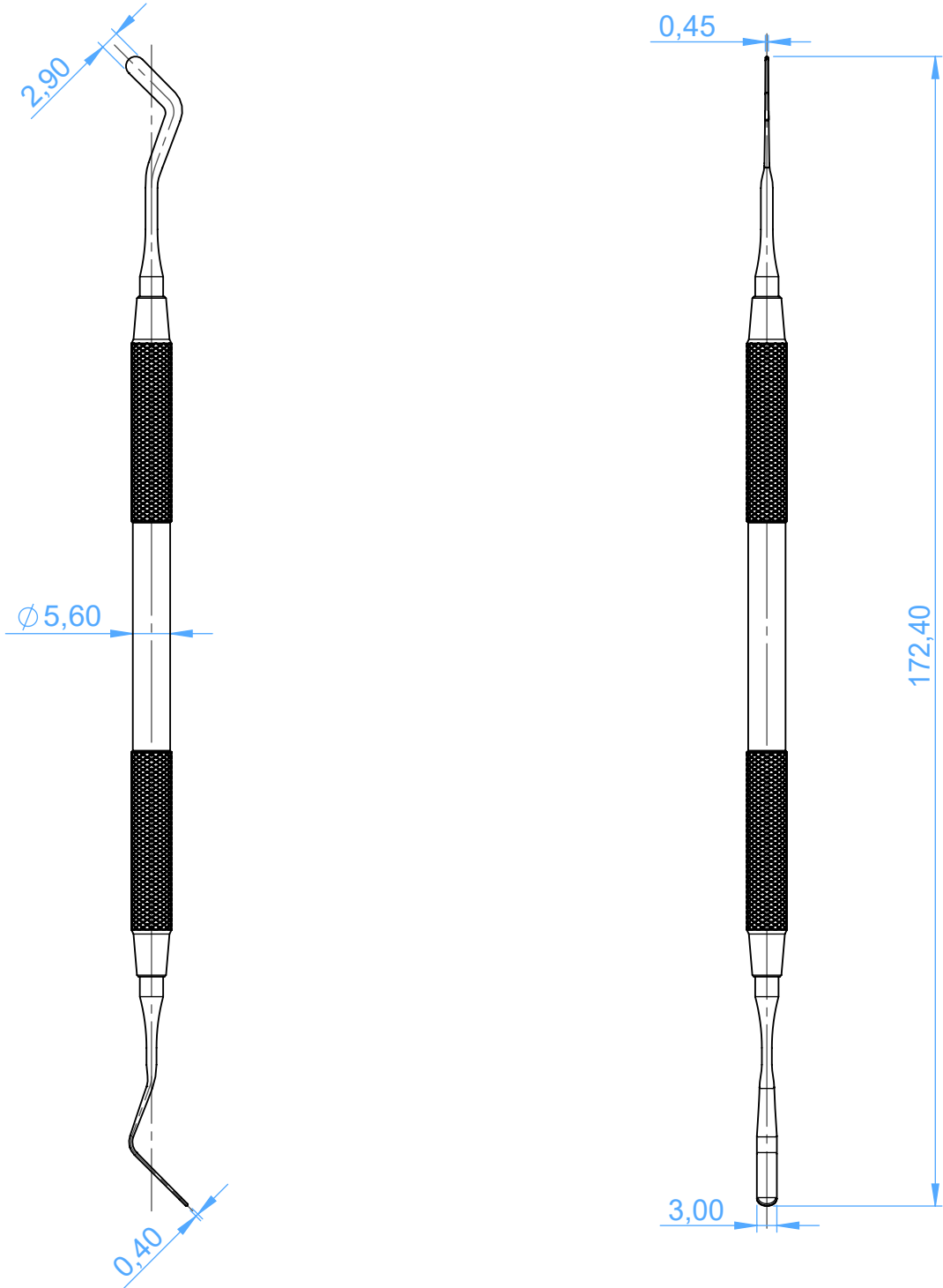

Scale 1:1