

0498-PF5 Ostotomes

Ø 5 mm

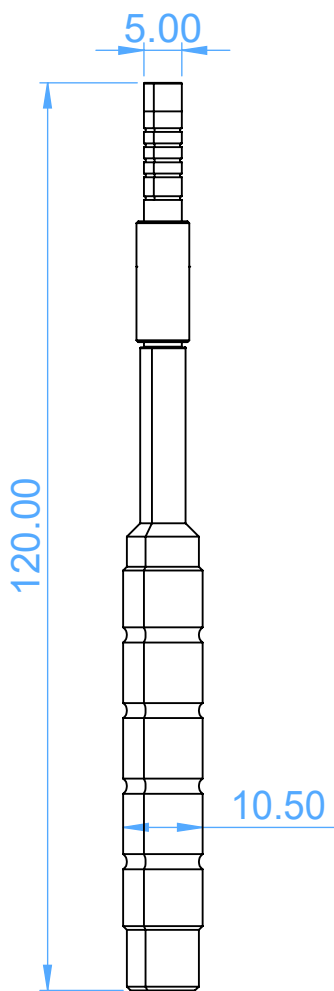

Scale 1:1