

0498-PF4 Ostotomes

Ø 4 mm

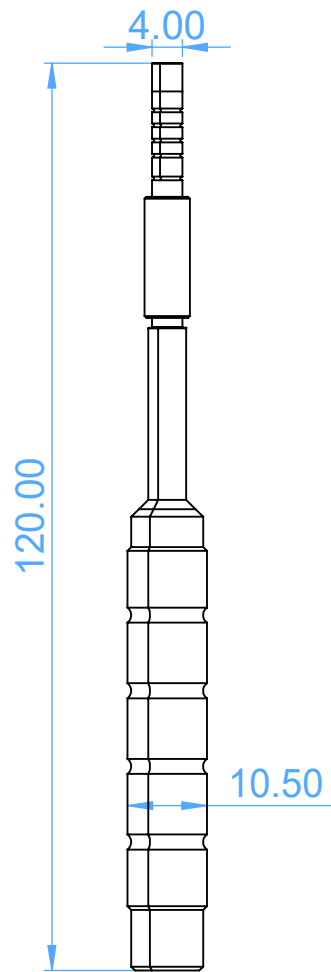

Scale 1:1