

0498-2C4
Osteotomes

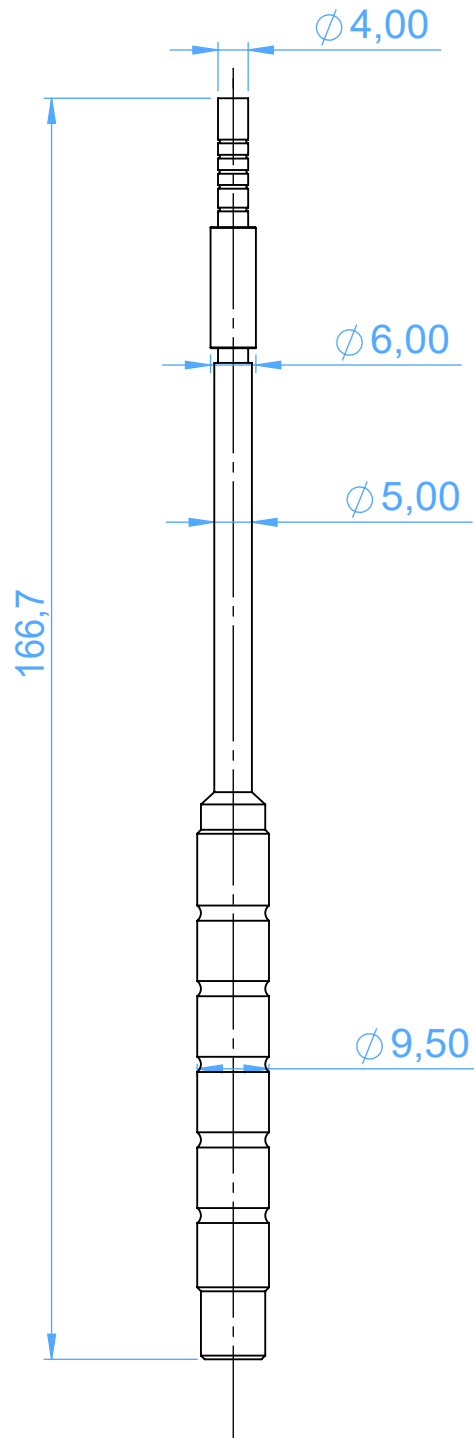

Scale 1:1