

0296-25 Syndesmotomes

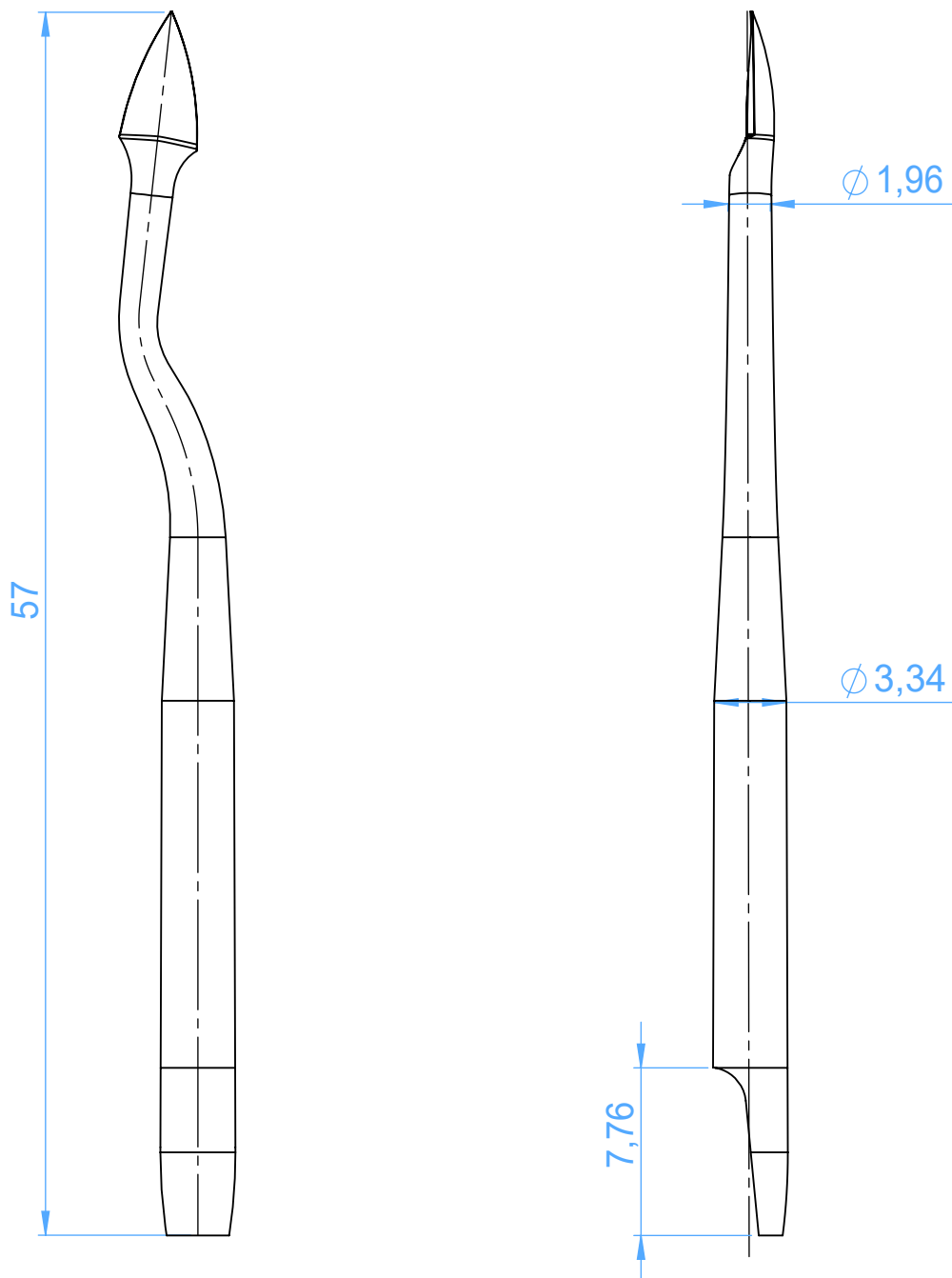

Scale 3:1